



IM-Mounting

type 10-IM-130-A

Max. 120 kg - 4 mm - 8 Hz

IM-Mountings are very suitable for mobile applications. These compact anti-vibration mountings are easy to install and offer a high level of vibration insulation. The integrated rebound control-device limits excessive movement under shock loads. IM-Mountings are available in several rubber mixes to accommodate a large load range. These mountings can be supplied with a height adjustment feature.

Applications: marine propulsion-engines, generator sets, pump units, compressor sets, etc.

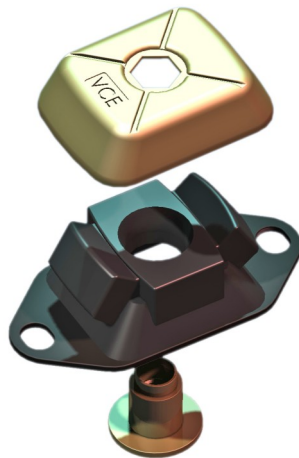
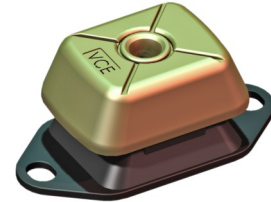

LOAD CHARACTERISTICS

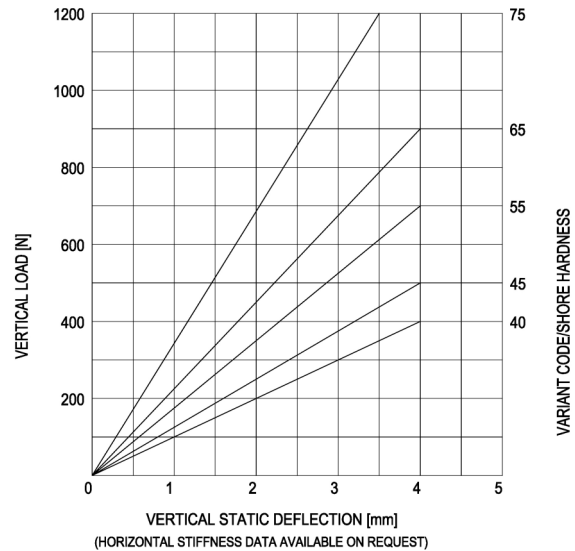

SIDEVIEW

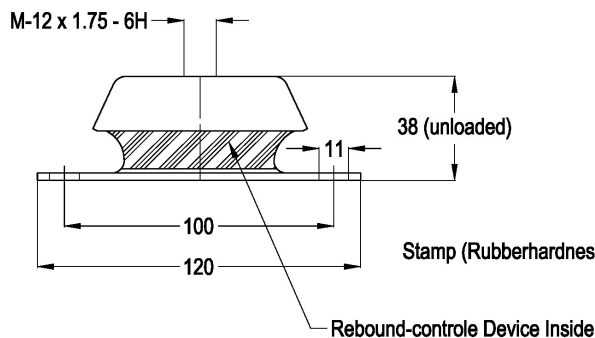

TOPVIEW

